

70

OPERATING INSTRUCTIONS & SERVICE MANUAL

AM/FM STEREO AMPLIFIER

SANSUI AU-6500

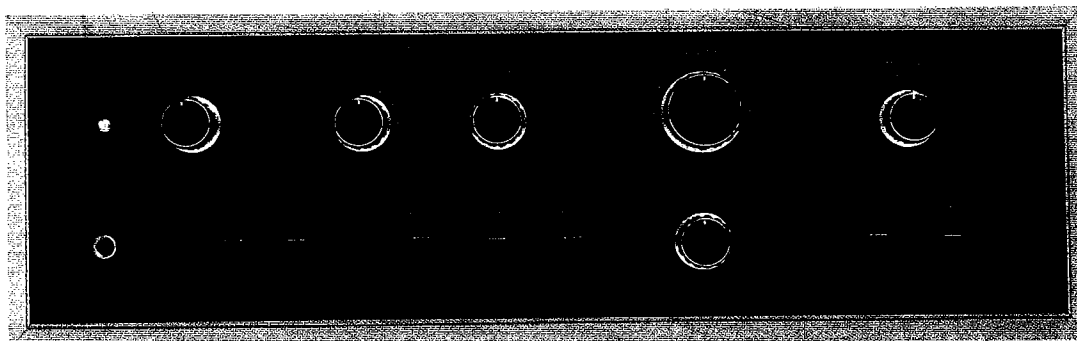

Sansui

SANSUI ELECTRIC CO., LTD.

We are grateful for your choice of the AU-6500 Integrated Amplifier.

For over a quarter of a century, Sansui has been building hi-fi audio equipment, and nothing else. Our mission is very old and at once ever new to us: to bring the reproduced sound closer and closer to the original.

The AU-6500 now in your hands is one answer from us to this never-ending quest. It is a product of the cream of sophisticated modern audio-electronics knowhow, coupled with our long experience, and as such, we present it to you with our full confidence.

The AU-6500 is a new breed of Sansui's AU series integrated amplifiers. Its tone quality has been polished and perfected through an unprecedented number of listening tests in different acoustic environments. We feel certain that you will like it, but you will find this out as soon as you play your first record through it.

This manual has been prepared to guide you in operating and caring for the amplifier correctly, so that you will get the most out of its built-in high performance and exceptional versatility.

May we suggest that you read it once carefully?

CONTENTS

SWITCHES AND CONTROLS.....	3, 4
SETTING UP YOUR AU-6500/ OPERATING PROCEDURE	5, 6
RECORDING AND PLAYBACK BY TAPE DECK	7
UPGRADING YOUR STEREO (4-CHANNEL STEREO SYSTEM/ELECTRONIC CROSSOVER SYSTEM)	8
SIMPLE MAINTENANCE HINTS/ACCESSORY LIST.....	9, 10
QUICK CHECK LIST OF SIMPLE MISTAKES.....	11
SPECIFICATIONS	12
SCHEMATIC DIAGRAM	13, 14
NOTES TO SERVICE ENGINEERS	15
GENERAL TROUBLESHOOTING CHART	16
DISASSEMBLY PROCEDURE	17
ALIGNMENT.....	18
PRINTED CIRCUIT BOARDS AND PARTS LIST.....	19~24
OTHER PARTS AND THEIR POSITION ON CHASSIS...	25, 26

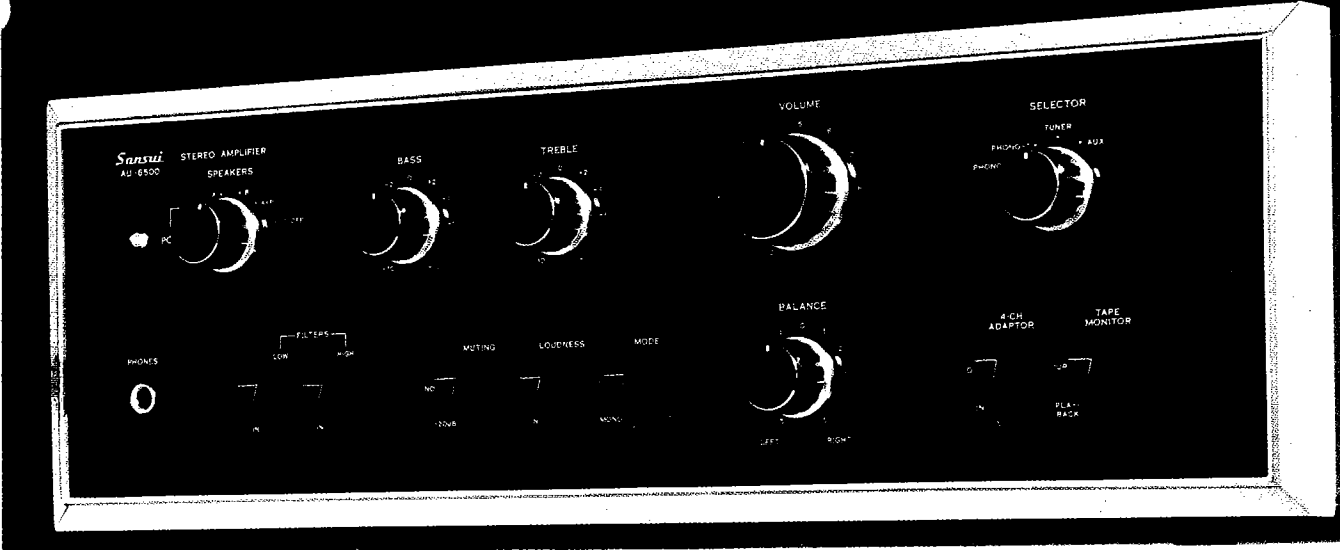

SWITCHES AND CONTROLS

Power Indicator

Lights when you turn on the Power/Speakers Switch, and remains lit until you turn off the switch.

Power/Speakers Switch

Controls both the power supply and selection of speaker systems.

POWER OFF: Cuts off power supply for the amplifier.

A: Turns on power supply and energizes the speaker systems connected to SYSTEM-A speaker terminals on the rear.

Because of the built-in amplifier/speaker protection circuit, sound will come out with a delay of a few seconds.

B: Energizes speaker systems connected to SYSTEM-B speaker terminals.

A+B: Energizes both A and B pairs of speaker systems.

SPKR OFF: Cuts off the sound from all speaker systems to permit private listening with headphones connected to the Headphone Jack.

Headphone Jack

Plug stereo headphones into this jack for private listening or monitoring, but be sure to turn the Power/Speakers Switch to SPKR OFF first unless someone is listening to the sound from speaker systems in another room. The jack will accept any standard stereo phone plug, but for best tone quality, we recommend a dynamic type such as the Sansui SS-20 or SS-10.

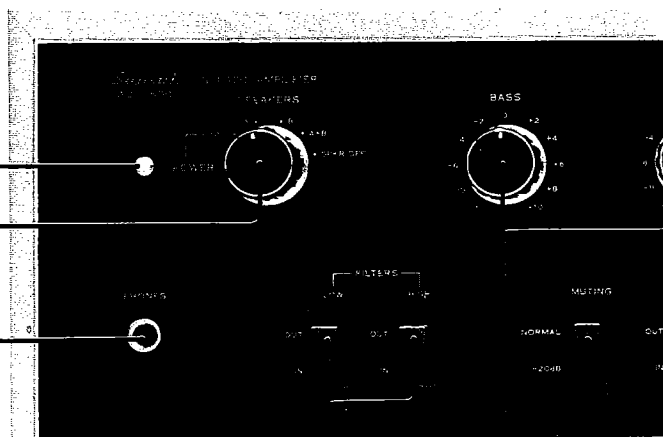

Filters

Low: Push down to IN to eliminate low-frequency noise such as the rumbling of your turntable motor. If no such noise is present, be sure to keep it off.

High: Push down to IN to eliminate high-frequency noise such as the surface noise from a worn record or as the fluorescent lamp noise mixed in radio broadcasts.

Tone Controls

Let you tailor the tone quality of reproduced sound to your taste by adjusting the amplifier's frequency response curve. The Bass Control is for adjusting the loudness of bass notes as may be produced by a bass, and the Treble one for adjusting that of treble notes as may be produced by cymbals.

Muting Switch

Reduces the sound volume by 20dB at once without the use of the Volume Control. Most convenient to lower the sound volume temporarily when the telephone rings, to avoid the noise of the pickup stylus descending on a record, etc.

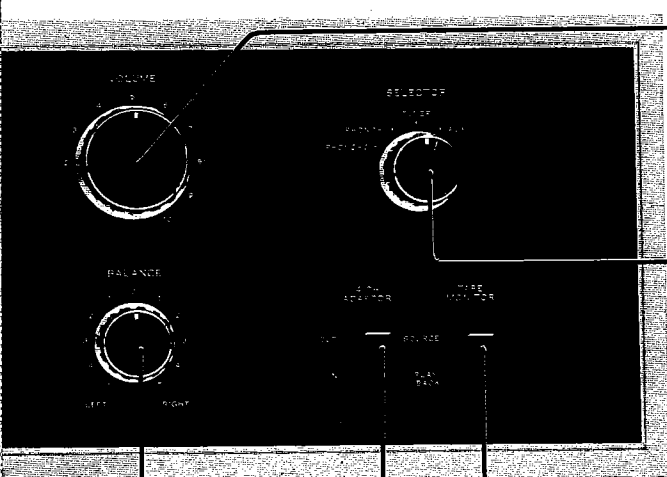

Volume Control

Selector Control

Turn to an appropriate position to hear the desired program source.

PHONO-2, PHONO-1: To play records on a turntable connected to the PHONO 2 or 1 terminals on the rear.

TUNER: To hear a radio broadcast from a tuner connected to the TUNER terminals on the rear.

AUX: To reproduce whatever program source is connected to the AUX terminals on the rear. (Connect a turntable with a crystal or ceramic cartridge, the audio outputs of a television, the playback outputs of a tape recorder, etc. to the AUX terminals.)

Balance Control

Push down the Mode Switch to MONO once and adjust this control for equal sound volume from the left and right speaker systems, then return the switch to STEREO. If there is a large difference in the sound volumes from the two speaker systems even with this control set near the center, it may be because the left and right output signal levels from the program source component (turntable, tuner, tape deck, etc.) are different. Check the component once.

Mode Switch

The STEREO position is normal. If you connect a monophonic signal to either left or right input terminal, it is heard from both speaker systems by pushing down to MONO.

Loudness Switch

If desired, push down to IN to emphasize the highs and lows when listening at low volume levels. This is because the mechanism of human hearing is such that the high and low notes seem greatly enfeebled at low listening levels.

Tape Monitor Switch

Push down to PLAYBACK to reproduce a recorded tape or monitor a recording as you make it on a tape deck connected to the amplifier (monitoring is possible only if the tape deck is equipped with separate recording and playback heads). Otherwise, be sure to keep it at SOURCE.

4-Channel Adaptor Switch

If you connect a 4-channel adaptor to the AU-6500 and make other necessary connections, you can upgrade this 2-channel stereo amplifier to hear 4-channel stereo sound by pushing this switch down to IN. (refer to page 8). Otherwise, be sure to keep it off.

SETTING UP YOUR AU-6500 / OPERATING PROCEDURE

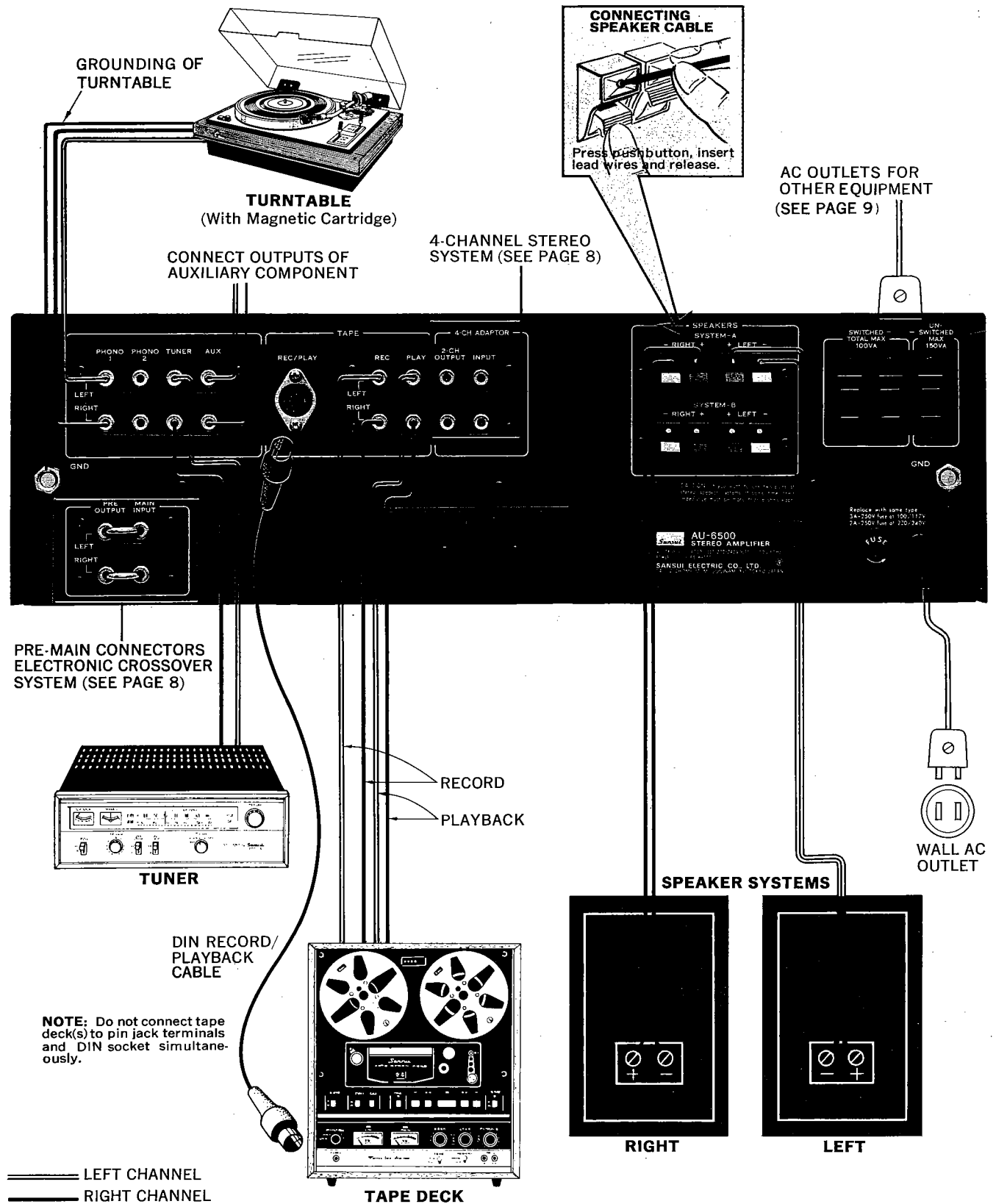

Connecting Speaker Systems

If you are connecting only **one pair of speaker systems** to the AU-6500, they may have any impedance from 4 to 16 ohms. Connect them to the SYSTEM-A or -B terminals on the rear, making sure not to confuse the left and right cables, plus and minus leads on the amplifier and speaker ends. But if you wish to connect **two pairs of speaker systems** and drive them simultaneously by turning the Power/Speakers Switch to A+B, each speaker system should have impedance of 8 to 16 ohms. Using a system with lower impedance could result in a breakdown of the amplifier.

Connecting a Turntable

Connect it to the PHONO 1 or 2 terminals on the rear. For best results, use a turntable with a magnetic pickup cartridge.

Connecting a Tuner

Connect the output terminals of a tuner to the TUNER input terminals on the amplifier's rear panel.

Connecting Grounding

Be sure to connect the grounding terminal (or lead) of the turntable and tuner to the grounding terminal of the amplifier. It may suppress the hum noise which may otherwise occur.

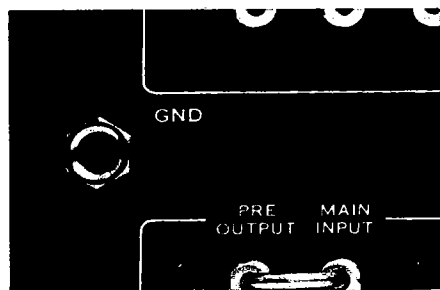

Operating Procedure

1. Set the Selector Control to the desired program source.
2. Set the 4-Channel Adaptor Switch to OUT and the Tape Monitor Switch to SOURCE, unless you want to use them.
3. Set the Power/Speakers Switch to as required.
4. Start the program source component and play the program source.
5. Use the amplifier's other controls and switches to suit your taste or room acoustics.

Note: To play a monophonic record on a stereo turntable, follow the same procedure as for playing a stereo record. Better results are normally obtained.

RECORDING AND PLAYBACK BY TAPE DECKS

Connecting a Tape Deck

Connect the input terminals of a tape deck to TAPE REC terminals of the amplifier, and its output terminals to the PLAY terminals.

The DIN socket can be used only if your tape deck is equipped with a similar socket. It is manufactured according to the German industrial standard to permit tape recording and playback from a single cable with a special 5-pin plug on each end.

Should you wish to connect more than two tape decks, you may connect it to the 4-CH ADAPTOR terminals. The 2-CH OUTPUT terminals have the same electrical function as the REC terminals, while the INPUT terminals are equivalent to the PLAY terminals.

Note: Do not connect the tape deck(s) to the pin jack terminals and DIN socket simultaneously.

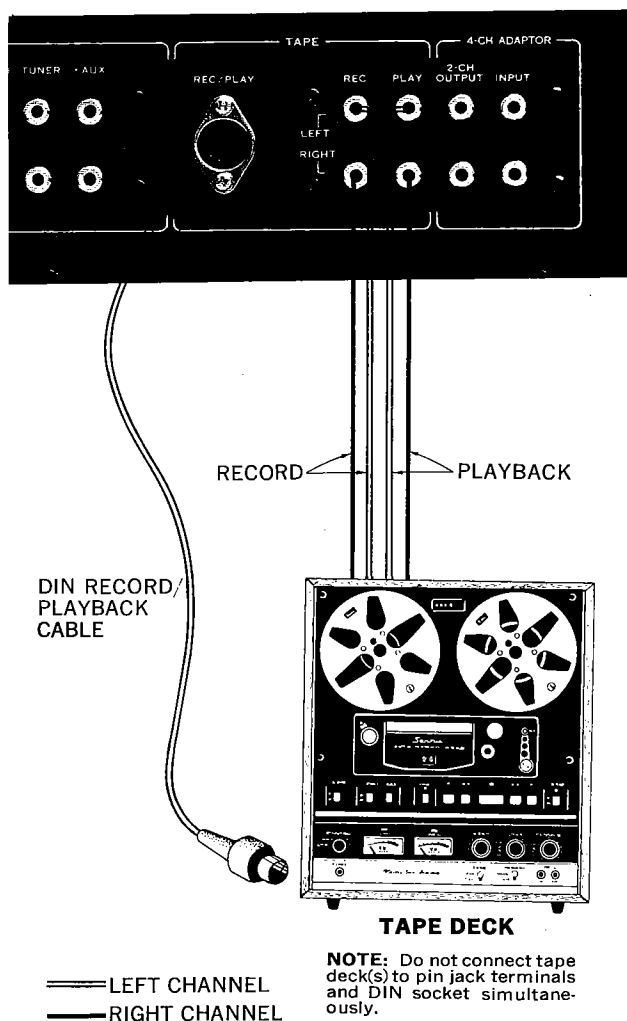

Recording & Playback Procedure

Recording

1. Set the Selector Control to the program source you wish to record.
2. Adjust the recording volume control of the tape deck to preset the recording level.
3. Start the tape deck in the recording mode.
4. To monitor the recording as you make it, push down the Tape Monitor Switch to PLAYBACK. Be sure to set the monitor switch of the tape deck to the playback mode as well.

Playback

1. Set the Tape Monitor Switch to PLAYBACK.
2. Start the tape deck in the playback mode.
3. Use the amplifier's other switches and controls to suit your taste or room acoustics.

Procedure for Copying a Recorded Tape

◇ If you want to copy a recorded tape, connect one tape deck for playback to the TAPE terminals, the other for recording to the 4-CH ADAPTOR terminals.

◇ By operating the 4-Channel Adaptor Switch, you can monitor the recording as you copy it from one tape deck to the other. To monitor the recording before it is copied, keep the 4-Channel Adaptor Switch at OUT. To monitor the recording after it is copied, push down to IN.

Notes about Recording

1. Monitoring of recorded sound is possible only if the recording tape deck is equipped with separate heads for recording and playback. Otherwise, set the Tape Monitor Switch to SOURCE and listen to the original input sound before it is recorded.
2. The various switches and controls on the AU-6500 do not affect the sound recorded into the tape deck. They only adjust the sound from the speaker systems or headphones.

UPGRADING YOUR STEREO

4-Channel Stereo System

The sound we hear daily is a mixture of the sound that reaches our ears straight from the sound source—be it a musical instrument, a jet, a man's mouth or what have you—and the 'indirect sounds' that arrive at our ears only after they are reflected off various surfaces, such as the walls, ceiling and so forth. Four-channel recordings are made using two microphones in the front of the concert hall and two in the rear (to simplify the explanation). The 'indirect sounds' with their complicated waveforms are mainly picked up by the two microphones in the rear, and reproduced out of the two rear speakers in a 4-channel stereo set-up for greatly enhanced 'ambience' effects. The effect is almost as if the original live performance were re-played right in your own room.

This new approach can now be yours simply by adding certain equipment—mainly, a Sansui 4-channel rear amplifier with its unique QS Regular matrix (patents pending), and a second pair of speaker systems—to your 2-channel stereo system. Connection of such a rear amplifier or 4-channel adaptor is easy. Just connect the 4-CH ADAPTOR 2-CH OUTPUT terminals of the AU-6500 with the input terminals of such rear amplifier or 4-channel adaptor, then connect its 4-CH ADAPTOR INPUT terminals with the output terminals of such unit.

To operate the rear amplifier or 4-channel adaptor so connected, push the 4-Channel Adaptor Switch on the amplifier's front panel, and otherwise follow its manufacturer's instructions. Electrically, the 4-CH ADAPTOR 2-CH OUTPUT and INPUT terminals possess the same functions as the TAPE REC and MON terminals, respectively.

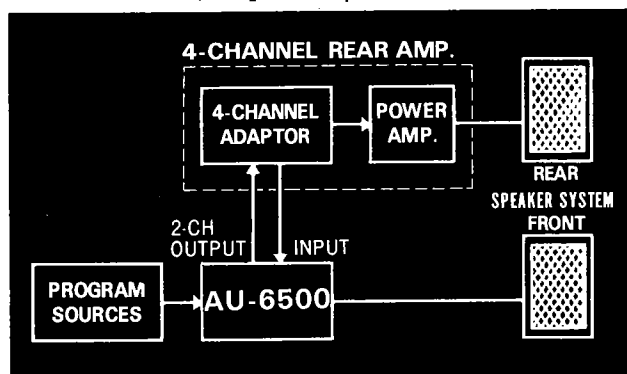

Electronic Crossover system

The electronic crossover system affords these advantages:

1. It enables the tweeters, midranges and woofers to be driven by separate power amplifiers. So you can make optimum use of speakers of different impedances and efficiencies, as well as power amplifiers of different output capacities and tone qualities.
2. It eliminates the need for the conventional LC type crossover network. With the electronic crossover divider, the amplifier's damping factor is no longer affected and you can set crossover frequencies as you like.

Electronic Crossover System Using the AU-6500

The preamplifier and power amplifier sections of the AU-6500 can be disconnected for independent usage, the latter section being available for driving a separate speaker in an electronic crossover system. To build such a system, you will need two- or three-way speaker systems and an electronic crossover divider, along with at least one or two additional power amplifiers.

Connection is not all that difficult. First remove the Pre-Main Connectors uniting the amplifier's pre-amplifier outputs and main (power) amplifier inputs. Then just connect the PRE OUTPUT to the input terminals of the electronic crossover divider, which divides the input signals into high, medium and low range(s). Finally, couple the separate output terminals of the electronic crossover divider to the amplifier's MAIN INPUT and the additional power amplifier(s), feeding their outputs separately into individual speakers, as illustrated below.

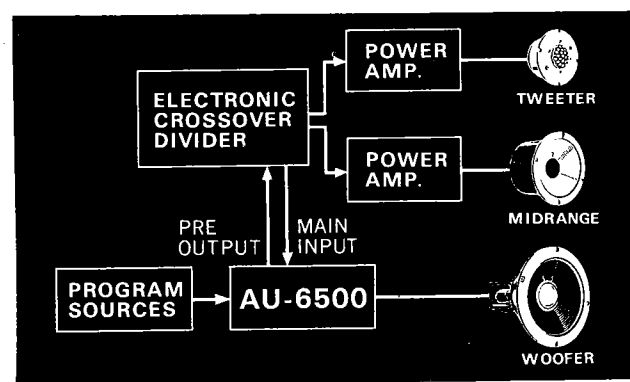

SIMPLE MAINTENANCE HINTS / ACCESSORY LIST

Rear-Panel AC Outlets

Of the three AC outlets provided on the rear panel, the ones marked 'SWITCHED' are controlled by the front-panel Power/Speakers Switch. The third one, marked 'UNSWITCHED,' is always 'live' and independent of the Power/Speakers Switch. The voltage delivered at these AC outlets is the same as the power supply voltage used.

The two 'SWITCHED' outlets have a total power capacity of 100 VA, while the UNSWITCHED one 150VA. Before you connect any appliance to them, be sure that it is adjusted for use at the same power supply voltage, and that its power consumption is not beyond these figures. Otherwise, serious danger could result.

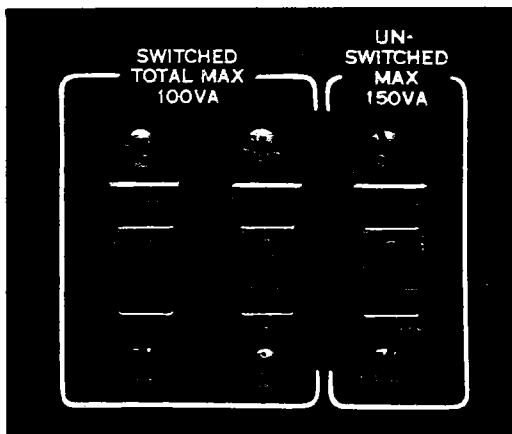

Make Proper Connections

Connect the loadwires of speaker cables properly. If they are loose or touch other parts, the amplifier may produce noise and eventually break down. Also, before connecting a turntable, tuner and/or tape deck, be sure to read their manufacturers' instructions.

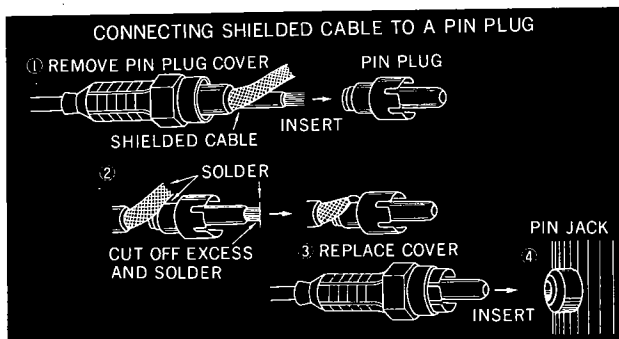

Speaker Impedance

Do not ever connect two pairs of speaker systems with impedance of less than 8 ohms each. Doing so will reduce the composite speaker impedance in each channel to less than 4 ohms, and may cause the quick-acting fuses to blow or result in a more serious breakdowns over a long period of time.

Phasing of Speakers

Listen to any monophonic reproduction. If the speaker systems are correctly phased, the sound will seem to come from a point midway between the left and right speaker systems. If the sound is not directly in front of you, however, the speaker systems are out of phase. If you notice this condition, check the speaker connections once. To correct the condition, switch the amplifier off and reverse the connection of plus and minus leadwires of one speaker cable. Also, be careful not to connect a single speaker system between the SYSTEM-A and SYSTEM-B terminals by mistake.

Howling and Hum

Take care never to place a turntable on or too near a speaker system, or the vibration produced by the speaker system is transmitted and causes an oscillating phenomenon called howling. It is best to keep these components completely separated, but if this is impossible, place a thick cushion between them. Humming, in contrast, is a phenomenon caused by incomplete or incorrect turntable-amplifier connections. Should this occur, check to see if all connections are completely made and if the connecting cables are sufficiently thick. Hum noise may sometimes be eliminated by connecting the grounding lead of the turntable to the GND terminal on the amplifier's rear.

Voltage Adjustment

Your AU-6500 is adjusted to operate at the correct power supply voltage of your area prior to shipment from our factory. If you move after purchasing it or send it as a gift to a friend living in an area where the voltage is different, it may be necessary to adjust its Voltage Selector. To adjust it, remove the two screws securing the name plate on the rear, then set the arrow mark on the Voltage Selector Plug to the correct voltage indication (100, 117, 220, or 240 volts).

Also, it may be necessary to replace the power fuse as will whenever the voltage has changed. For operation at 100—117 volts, use a 3-ampere fuse. For operation at 220—240 volts, use a 2-ampere one.

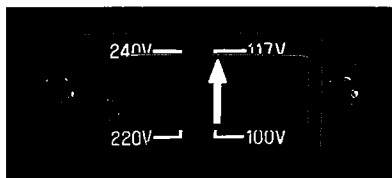

117V (POWER FUSE 3A)

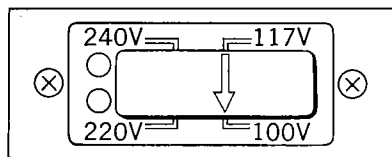

100V (3A)

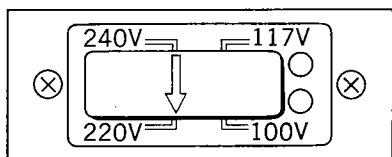

220V (2A)

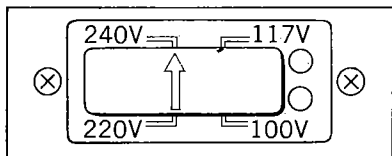

240V (2A)

Heat Radiated inside the Amplifier

The bonnet of the AU-6500 is designed so that any heat radiated inside will effectively escape through it. Proper care should therefore be taken of the dissipation of such heat if you wish to place something on top of the amplifier or place it inside a closed box, etc. Above all, avoid placing it where it may be exposed to the direct sunlight.

It is prohibited, however, to remove the amplifier's bonnet or bottom plate to improve the ventilation.

Accessory List

1. OPERATING INSTRUCTIONS AND SERVICE MANUAL	1
2. OPERATING INSTRUCTIONS SHEET	1
3. PIN PLUGS.....	4
4. BUTTERFLY BOLTS	2
5. WASHERS	2
6. POLISHING CLOTH.....	1
7. QUICK-ACTING FUSES (3A).....	2

QUICK CHECK LIST OF SIMPLE MISTAKES

Some of the troubles which seem to result from a malfunction of the amplifier are caused by wrong operation and the negligence of simple maintenance, and can be quickly corrected by making a simple investigation and providing simple cures. To make sure you haven't made any of these mistakes, go over the following check list once.

Connections

1. Have you connected the power cord to a wall AC outlet?
2. Are the connecting cables for the turntable and tape deck not loose?
3. Are the speaker cables not loose from amplifier's jacks or the speaker systems?
4. Do your speaker systems have impedance of 8 ohms more? (They must, if you want to drive two pairs at one time.)
5. Have the power fuse or quick-acting fuses not blown?

Operating Procedure

1. Have you turned on the Power/Speakers Switch?
2. Is the Tape Monitor Switch not set to PLAY-BACK position, though you don't want to reproduce a tape?
3. Is the Selector Control set to the correct position?
4. Is the Power/Speakers Switch set to the correct position?
5. Is the 4-Channel Adaptor Switch not pushed down, though you are not using a 4-channel rear amplifier or adaptor?

If, even after these examinations, the amplifier does not return to normal, it may be faulty. Contact the Sansui dealer from whom you purchased the amplifier or your nearest Sansui Authorized Service Station. Do not attempt opening the bonnet for yourself. Such repair must be left to a qualified serviceman.

Should the Power Fuse Blow

If no Power Indicator should glow and the amplifier simply remains dead even after you have turned on its power fuse has blown. If this happens, disconnect the power cord from the wall AC outlet at once and examine the power fuse on the rear panel. If you find it blown, replace it with a new glass-tubed fuse of the rated capacity (3-ampere for 100 to 117 volts, 2-ampere for 220 to 240 volts). Never use a fuse of a different capacity or a piece of wire, even as a stop-gap measure, or serious danger could result.



Quick-Acting Fuses

The AU-6500 is doubly protected with a relay-equipped protection circuit and four quick-acting fuses. If no sound or distorted sound is heard from either or both speaker systems, switch off the amplifier, disconnect the power cord from the wall AC outlet, remove the cover on the rear panel concealing the quick-acting fuses and examine them. If you find any of them blown, find and eliminate the cause of the blowout, then replace it with a new glass-tubed quick-acting fuse supplied.

If the relay-equipped protection circuit ever goes to work, the sound may come out intermittently. If it happens, check the connections of various equipment and your operating procedure once.



SPECIFICATIONS

POWER OUTPUT

IHF MUSIC POWER: 94W (4 Ω) at 1,000Hz
CONTINUOUS RMS POWER
(each channel driven): 32/32W (8 Ω) at 1,000Hz
CONTINUOUS RMS POWER
(both channels driven): 30+30W (8 Ω) at 1,000Hz

TOTAL HARMONIC DISTORTION:
less than 0.1% at rated output

INTERMODULATION DISTORTION (70Hz:7,000Hz
=4:1 SMPTE method): less than 0.1% at rated output

IHF POWER BANDWIDTH
(each channel driven at 8 Ω):
5 to 40,000Hz

FREQUENCY RESPONSE (at 1Watt power output)
PHONO-1 and 2: RIAA equalization curve
 ± 0.5 dB (30 to 15,000Hz)
AUX: 10 to 30,000Hz ± 1.0 dB
MAIN INPUT: 10 to 40,000Hz ± 1.0 dB

LOAD IMPEDANCE: 4 to 16 Ω

DAMPING FACTOR: approximately 40 at 8 Ω load

INPUT SENSITIVITY AND IMPEDANCE (at 1,000Hz)
PHONO-1: 2.5mV (50k Ω)
PHONO-2: 2.5mV (50k Ω)
(Maximum input capability 300mV THD : less than 0.5%)
TUNER: 100mV (50k Ω)
AUX: 100mV (50k Ω)
TAPE PLAY (Pin): 100mV (50k Ω)
TAPE REC/PLAY (DID): 100mV (50k Ω)
4-CH ADAPTOR: 100mV (50k Ω)
MAIN INPUT: 800mV (40k Ω)

OUTPUT VOLTAGE(at 1,000Hz)
TAPE REC (Pin): 100mV
TAPE REC/PLAY (DIN): 30mV
4-CH ADAPTOR: 100mV
PRE OUTPUT: 0.8V
(THD: less than 0.08%)

(Maximum Output Voltage 4.0V
THD : less than 0.5%)

CROSSTALK (at rated output, 1,000Hz):
PHONO-1: better than 50dB
PHONO-2: better than 50dB
TUNER: better than 50dB
AUX: better than 50dB
MAIN INPUT: better than 50dB

IHF HUM AND NOISE
PHONO-1: better than 70dB
PHONO-2: better than 70dB
TUNER: better than 80dB
AUX: better than 80dB
MAIN INPUT: better than 100dB

SWITCHES & CONTROLS

BASS: +15dB, -15dB at 50Hz
TREBLE: +15dB, -15dB at 15,000Hz
LOUDNESS: +10dB at 50Hz, +8dB at
10,000Hz volume control at
-30dB)

LOW FILTER: -12dB at 50Hz (6dB/oct)
HIGH FILTER: -12dB at 10,000Hz (6dB/oct)

SEMICONDUCTOR: transistors; 35 diodes; 6
POWER REQUIREMENTS: 100, 117, 220, 240V 50/60Hz

POWER CONSUMPTION
MAXIMUM: 125VA
RATED: 65W

DIMENSIONS: 140mm (5 $\frac{9}{16}$ " H
440mm (17 $\frac{3}{8}$ " W
322mm (12 $\frac{1}{16}$ " D

WEIGHT: 11.5kg (25.3 lbs)

SCHEMATIC DIAGRAM

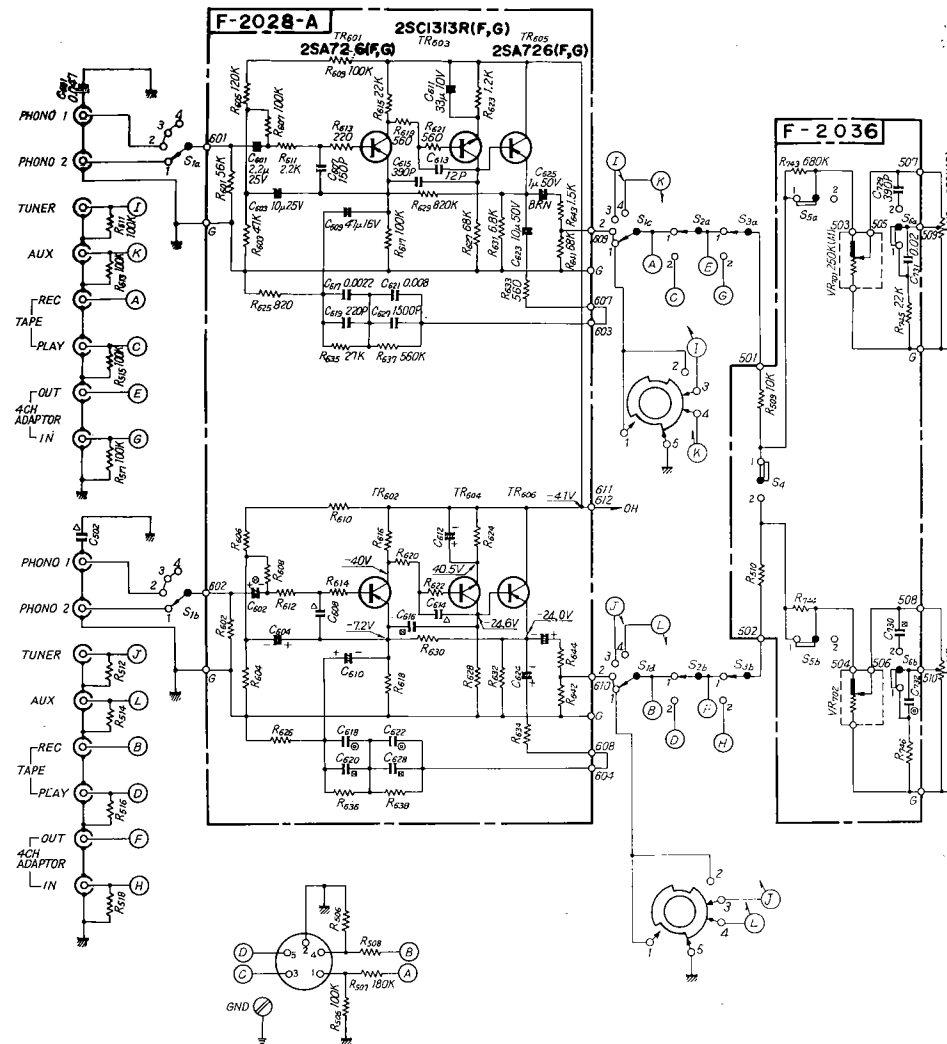

- S₁ (a-d) SELECTOR SW
 1. PHONO 2
 2. PHONO 1
 3. TUNER
 4. AUX
- S₂ (a,b) TAPE MONITOR SW
 1. SOURCE
 2. PLAY BACK
- S₃ (a,b) 4CH ADAPTOR SW
 1. OUT
 2. IN
- S₄ MODE SW
 1. STEREO
 2. MONO
- S₅ (a,b) MUTING SW
 1. NORMAL
 2. -20dB
- S₆ (a,b) LOUDNESS SW
 1. OUT
 2. IN
- S₇ (a,b) HIGH FILTER SW
 1. OUT
 2. IN
- S₈ (a,b) LOW FILTER SW
 1. OUT
 2. IN
- S₉ (a-e) POWER SW
 1. POWER OFF
 2. POWER ON
 3. " SR. SYSTEM A
 4. " SR. SYSTEM B
 5. " SR. SYSTEM A+B

- CAPACITORS
- △ CERAMIC
 - MYLAR
 - ⊗ STYROL
 - OIL

- VR_{101,102} BALANCE
- VR_{103,104} MASTER
- VR_{105,106} BASS
- VR_{107,108} TREBLE

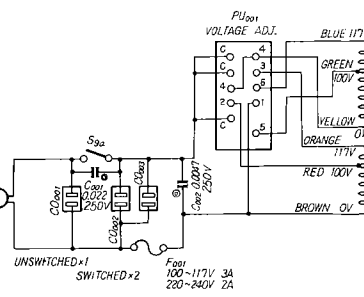
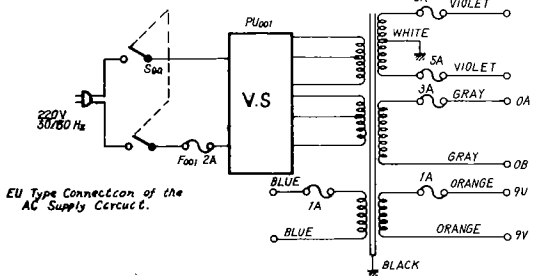

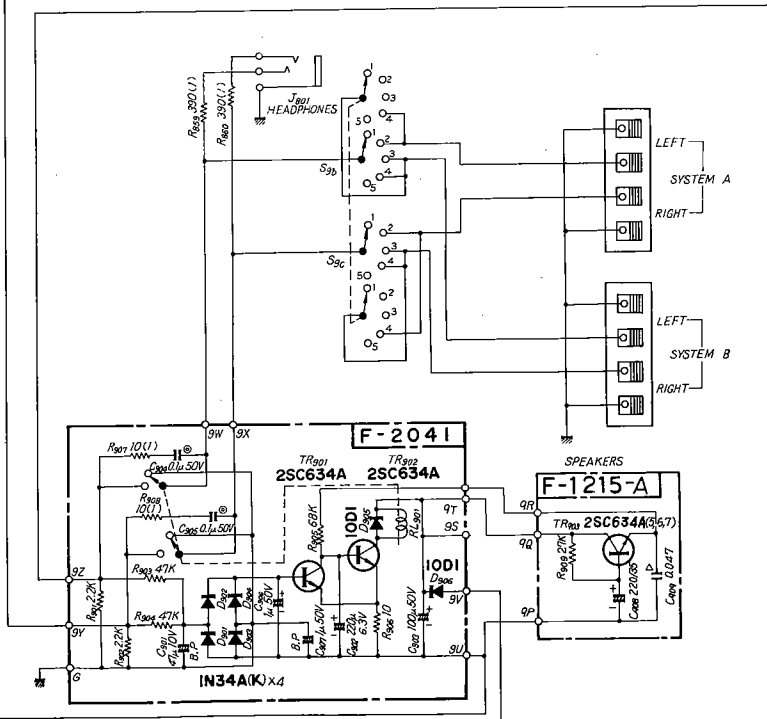
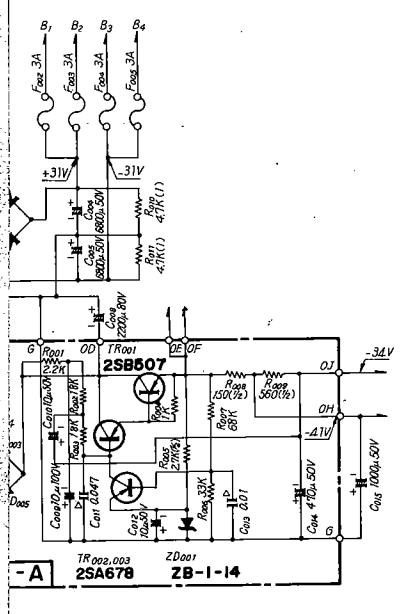
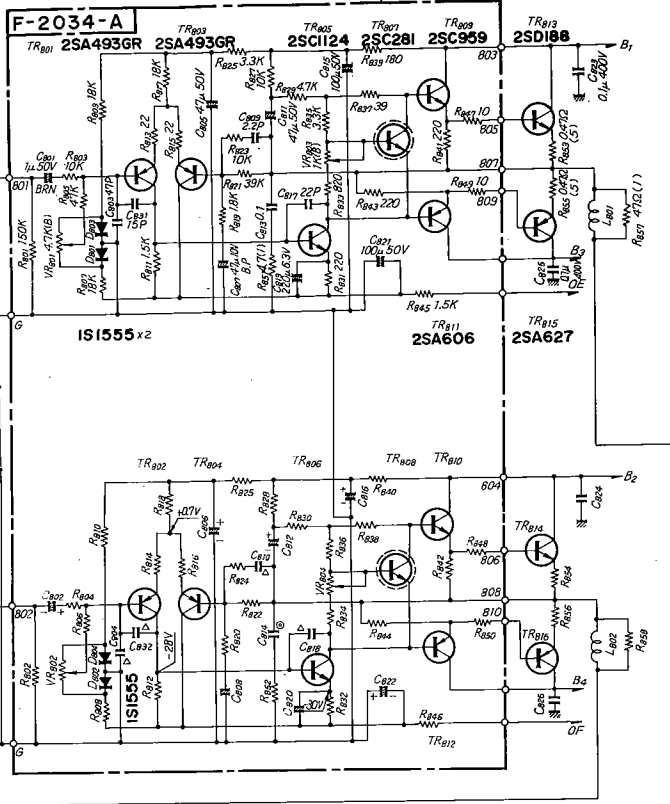
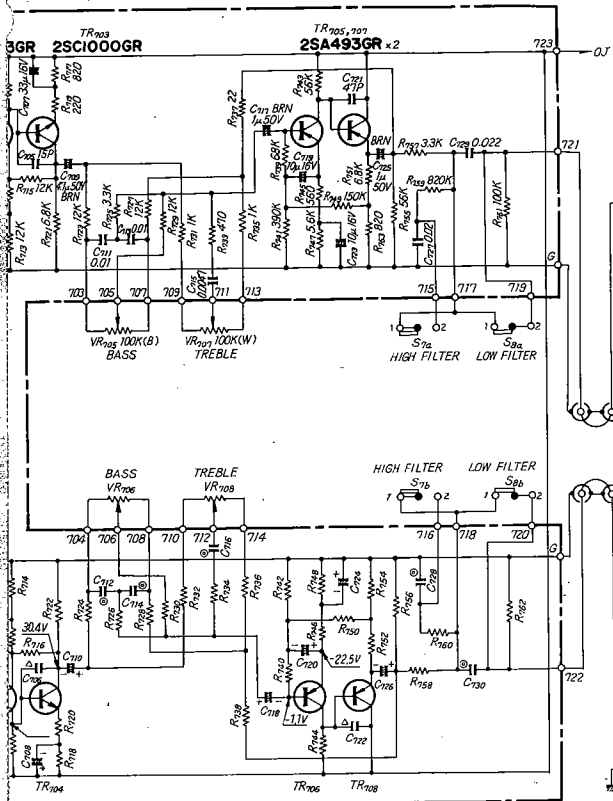

NOTES TO SERVICE ENGINEERS



■ Please contact the nearest Sansui Authorized Service Station for replacement parts. When ordering them, look up the part lists on pages 19 to 26 and let us know (1) the amplifier's model number, (2) name of the printed circuit board, (3) part No., (4) name of the part, and (5) its stock No. Using nonstandard parts for temporary relief often impairs the sound quality and over-all reliability of the amplifier. Please take the trouble to contact your nearest Sansui Authorized Service Station.

■ Consult pages 17 to 26 when making repairs or adjustments. To check or measure the amplifier performance, connect load resistance of 4 to 16 ohms to the amplifier's speaker output terminals first. To check the electrical output characteristics, do not remove the bonnet and bottom plate.

GENERAL TROUBLESHOOTING CHART

PROGRAM SOURCE	SYMPTOM	PROBABLE CAUSE	WHAT TO DO
Tuner.	* Noise during AM reception.	<ul style="list-style-type: none"> * Interference by adjacent stations (called beat interference). * TV set is being used simultaneously. 	<ul style="list-style-type: none"> * Peculiar to AM waves, and unavoidable to some extent. * Move TV set away from tuner and amplifier.
	* Noise heard at certain hours, in certain areas or over part of dial during AM reception.	* Interference by nearby electrical appliances.	<ul style="list-style-type: none"> * Attach noise limiter to appliance producing noise. * In some cases, can be eliminated by reversing power cord plug-AC outlet connections.
	* Pop noise during FM reception.	* Ignition noise from nearby automobile, motorcycle, etc.	<ul style="list-style-type: none"> * Adjust antenna location and height for maximum sensitivity. * Keep antenna away from streets. <p>Note: In many cases, high-frequency noise during radio reception cannot be entirely eliminated. Try turning on amplifier's High Filter Switch or turning Treble Control counterclockwise.</p>
Turntable.	* Hum noise.	<ul style="list-style-type: none"> * Unshielded cables used to connect turntable. * Minus (ground) wire of connecting cable is not connected completely. * Turntable motor or tonearm is not grounded. 	<ul style="list-style-type: none"> * Use regular shielded cables. * Examine connecting cables, especially their plugs. * Connect grounding lead of turntable to amplifier's GND terminal.
	* Loud oscillating noise.	* Turntable is placed on top of or too close to speaker systems.	<ul style="list-style-type: none"> * Place thick cushion between turntable and speaker systems. * Change location of turntable and speaker systems. * If using microphone(s), move or direct them away from speaker systems
	* Sound is shaky.	<ul style="list-style-type: none"> * Dust on record or pickup stylus. * Worn pickup stylus. * Improper stylus pressure. 	<ul style="list-style-type: none"> * Clean record and pickup stylus. * Replace pickup stylus. * Adjust stylus pressure.
Tape Deck.	* Hiss noise.	* Magnetic heads are magnetized.	<ul style="list-style-type: none"> * Demagnetize heads. * Turn on High Filter Switch. * Connect noise reduction adaptor.
	* Sound is not clear.	<ul style="list-style-type: none"> * Dust on magnetic heads. * Tape is not pressed tight to heads. 	<ul style="list-style-type: none"> * Clean heads. * Align tape transport mechanism.
General.	* When left and right channel sound volumes are balanced with amplifier's Balance Control, it does not come to center position.	<ul style="list-style-type: none"> * Left and right channel signal strengths vary with program source. * Left and right speaker systems have different efficiencies. 	* Never mind. Optimum stereo effect is obtained by adjusting Balance Control so that sound comes from midway point between two speaker systems with Mode Switch set to MONO.
	* Musical instruments and singer not located clearly.	* Left-right, plus-minus connections of speaker systems, input cables are wrong.	* Examine connections once.
	* Want to listen at very low volume level at night.	* Fine adjustment of very low volume cannot be done with Volume Control.	* Turn on Muting Switch, then adjust Volume Control.

DISASSEMBLY PROCEDURE

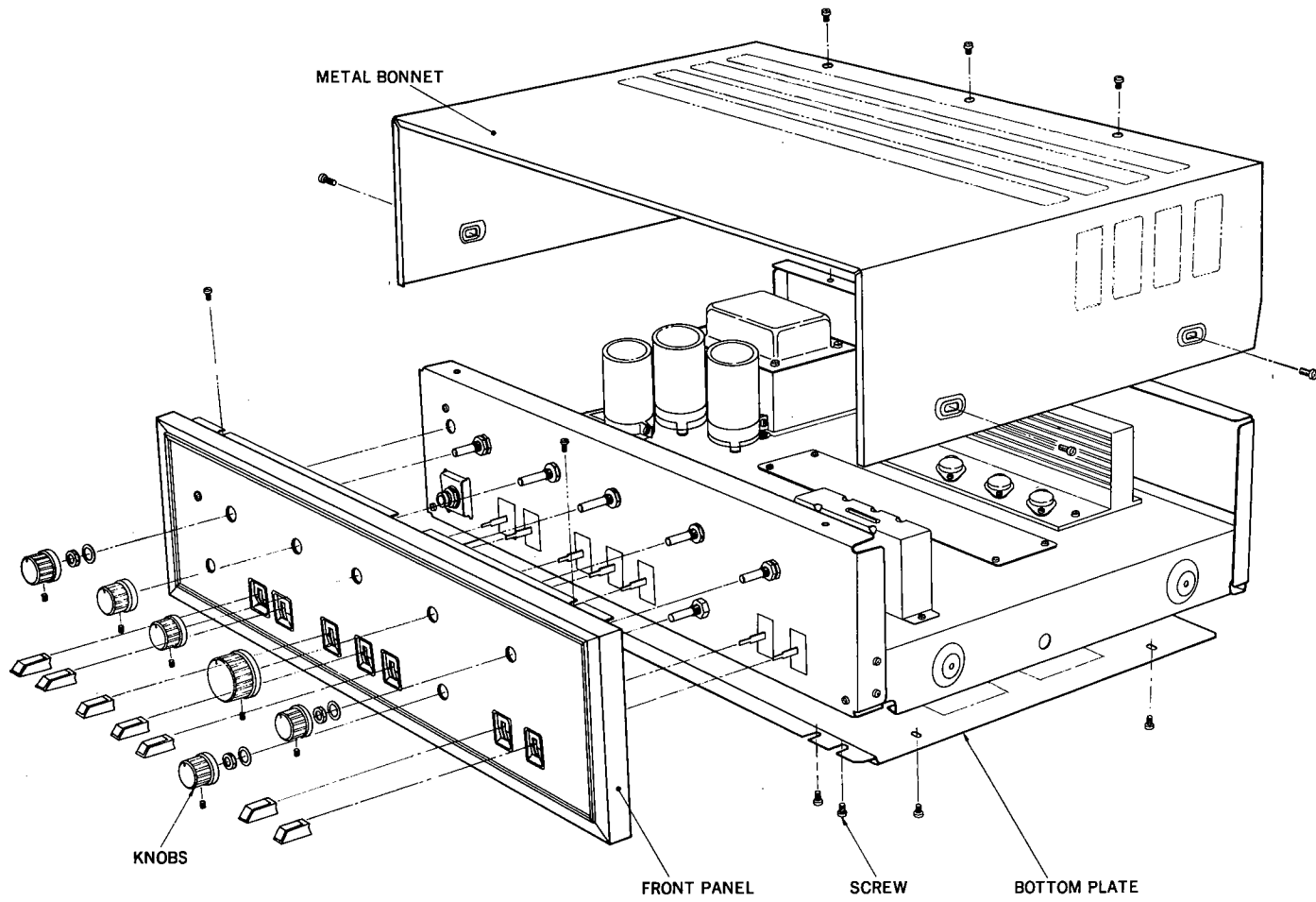

ALIGNMENT

Output of Power Amplifier Section

STEP	CONNECT/ADJUST	REMARKS
1.	Connect DC voltmeter to left (right) channel SYSTEM-A speaker terminals.	
2.	Turn Power/Speakers Switch to SYSTEM-A.	Set DC voltmeter to 0.5V~3V range.
3.	Adjust VR ₈₀₁ (VR ₈₀₂) so that voltmeter indicates 0V (within $\pm 30\text{mV}$). Repeat above procedure for right channel (notations in parentheses are for right channel).	

Current Alignment of Power Amplifier Section

STEP	AMMETER (TESTER)	CONNECT/ADJUST	REMARKS
1.		Remove F ₀₀₂ and F ₀₀₃ .	Use DC ammeter with 100mA or 50mA range.
2.		Turn VR ₈₀₃ and VR ₈₀₄ fully counterclockwise.	
3.		Turn Power/Speakers Switch to SPKR OFF.	
4.	Set to 100mA range.	Connect DC ammeter where F ₀₀₂ was. (Connect (21) on schematic to minus terminal of ammeter, other end to plus terminal.)	Don't have to need to connect load resistance to the SPEAKERS terminals.
5.		Adjust VR ₈₀₃ (left channel) so that ammeter indicates 28 to 32mA.	
6.		Turn off Power/Speakers Switch and replace F ₀₀₂ .	
7.	Set to 100mA range.	Turn Power/Speakers Switch to SPKR OFF, then connect ammeter where F ₀₀₃ was. (Connect (22) on circuit schematic to minus terminal of ammeter, other end to plus terminal.)	
8.		Adjust VR ₈₀₄ (right channel) so that ammeter indicates 28 to 32mA.	
9.		Turn off Power/Speakers Switch and replace F ₀₀₃ .	

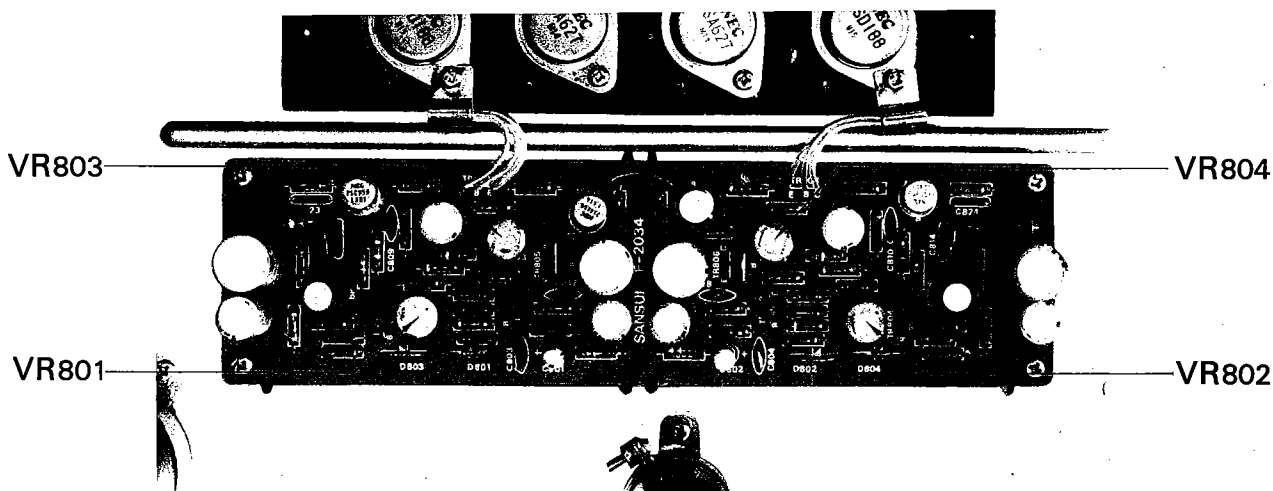

PRINTED CIRCUIT BOARDS AND PARTS LIST

W: Parts No. X: Parts Name Y: Stock No. Z: Position of Parts

DRIVER BLOCK <F-2034-A>

Stock No. 7570680

W	X	Y	Z
R801	150kΩ	0101154	2 B
R802	150kΩ	0101154	2 B
R803	10kΩ	0101103	2 B
R804	10kΩ	0101103	2 B
R805	47kΩ	0101473	2 A
R806	47kΩ	0101473	2 C
R807	18kΩ	0101183	2 A, B
R808	18kΩ	0101183	2 B, C
R809	18kΩ	0101183	2 A
R810	18kΩ	0101183	2 C
R811	3.3kΩ	0101332	2 A
R812	3.3kΩ	0101332	2 C
R813	39Ω	0101390	2 A
R814	39Ω	0101390	2 C
R815	39Ω	0101390	2 A
R816	39Ω	0101390	2 C
R817	18kΩ	0101183	2 A
R818	18kΩ	0101183	2 C
R819	1.8kΩ	0101182	2 A
R820	1.8kΩ	0101182	2 C
R821	39kΩ	0101393	1, 2 A
R822	39kΩ	0101393	1, 2 C
R823	10kΩ	0101103	1, 2 A
R824	10kΩ	0101103	1, 2 C
R825	3.3kΩ	0101332	2 A
R826	3.3kΩ	0101332	2 C
R827	10kΩ	0101103	1, 2 A
R828	10kΩ	0101103	1, 2 C
R829	4.7kΩ	0101472	1, 2 A
R830	4.7kΩ	0101472	1, 2 C
R831	180Ω	0101181	2 B
R832	180Ω	0101181	2 B
R833	820Ω	0101821	1 B
R834	820Ω	0101821	1 B
R835	3.3kΩ	0101332	2 A, B
R836	3.3kΩ	0101332	2 B, C
R837	39Ω	0101390	1 A
R838	39Ω	0101390	1 C
R839	180Ω	0101181	1 A
R840	180Ω	0101181	1 C
R841	220Ω	0101221	1 A
R842	220Ω	0101221	1 C
R843	220Ω	0101221	1 A, B
R844	220Ω	0101221	1 B, C
R845	1.5kΩ	0101152	1 B
R846	1.5kΩ	0101152	1 B
R851	10Ω	0104100	1 A
R852	10Ω	0104100	1 C
R847	10Ω	0101100	1 A
R848	10Ω	0101100	1 C
R849	10Ω	0101100	1 B
R850	10Ω	0101100	1 B
VR801	4.7kΩ(B)	1035110	2 A
VR802	4.7kΩ(B)	1035110	2 C
VR803	1kΩ(B)	1035070	1 A, B

W	X	Y	Z
VR804	1kΩ(B) DC Bias Adj. (Right)	1035070	1 B, C
C801	1μF	0519101	2 B
C802	1μF	0519101	2 B
C803	47pF	0660470	2 B
C804	47pF	0660470	2 B
C805	47μF	0515470	2 A
C806	47μF	0515470	2 C
C807	47μF	0531470	2 A
C808	47μF	0531470	2 C
C809	2.2pF	0660229	1 A
C810	2.2pF	0660229	1 C
C811	47μF	0515470	1 A
C812	47μF	0515470	1 C
C813	0.047μF	0601477	1 A
C814	0.047μF	0601477	1 C
C815	100μF	0515101	1, 2 A
C816	100μF	0515101	1, 2 C
C817	22pF	0660220	2 B
C818	22pF	0660220	2 B
C819	220μF	0510221	2 B
C820	220μF	0510221	2 B
C821	100μF	0515101	1, 2 B
C822	100μF	0515101	1, 2 B
C831	15pF	0660150	2 B
C832	15pF	0660150	2 B
TR801		0300450	2 B
TR802		0300450	2 B
TR803	2SA493 (GR)	0300450	2 A
TR804		0300450	2 C
TR805		0305901, 2	1, 2 B
TR806	2SC1124 (2, 3)	0305901, 2	1, 2 B
TR807		0305121, 2	1 A
TR808	2SC281 (B, C)	0305121, 2	1 C
TR809		0305741, 2	1 A
TR810	2SC959 (L, M)	0305741, 2	1 C
TR811		0300211, 2	1 B
TR812	2SA606 (L, M)	0300211, 2	1 B
D801		0311040	2 A
D802		0311040	2 C
D803	1S1555	0311040	2 A
D804		0311040	2 C
	Printed Circuit Board F-2034	2570460	

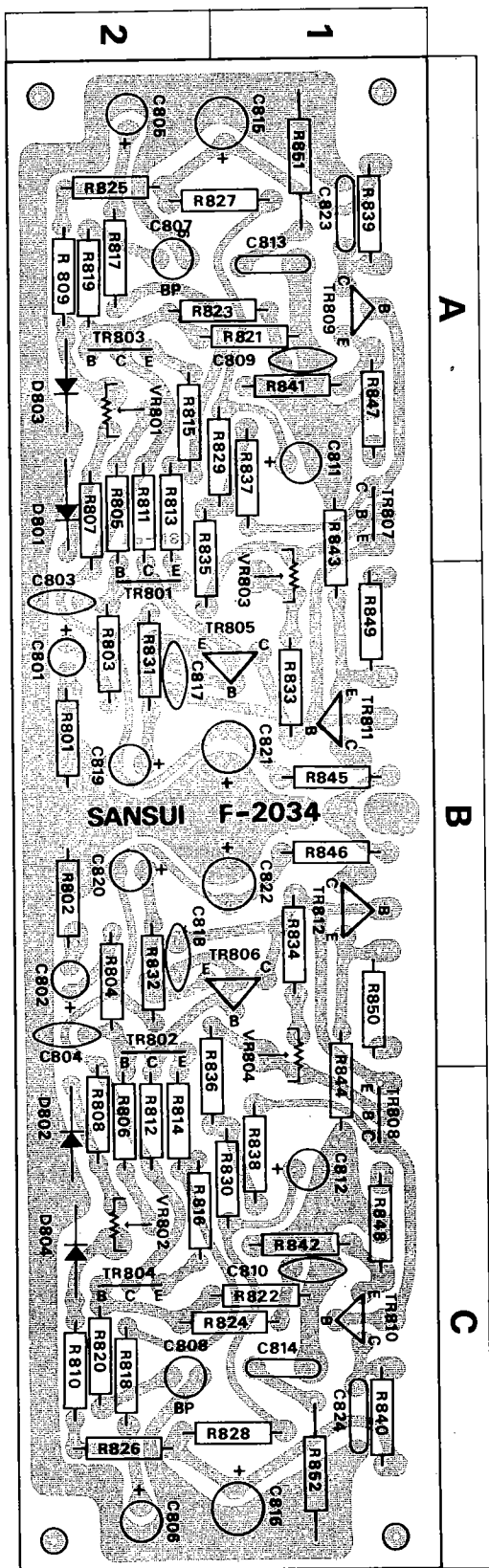

— Abbreviations —

- CR** : Carbon Resistor
- SR** : Solid Resistor
- CeR** : Cement Resistor
- CC** : Ceramic Capacitor
- EC** : Electrolytic Capacitor
- MC** : Mylar Capacitor
- MPC** : Metallized Polyester Capacitor
- SC** : Polystyrene Capacitor
- BPEC** : Bi-polar Electrolytic Capacitor
- TC** : Tantalum Capacitor
- OC** : Oil Capacitor
- MP** : Metallized Paper Film Capacitor

PRINTED CIRCUIT BOARDS AND PARTS LIST

W: Parts No. X: Parts Name Y: Stock No. Z: Position of Parts

PROTECTOR BLOCK

<F-2041>

Stock No. 7591230

<F-1215A>

Stock No. 7591230

W	X	Y	Z
R901	2.2k Ω	0101222	B
R902	2.2k Ω	0101222	A
R903	47k Ω	0101473	A
R904	47k Ω	0101473	A
R905	68k Ω	0101683	B
R906	10 Ω	0101100	B
R907	10 Ω	0111100	A
R908	10 Ω	0111100	A
R909	27k Ω	0107273	3C
C901	47 μ F	0531470	B
C902	220 μ F	0510221	B
C903	100 μ F	0515101	B
C904	0.1 μ	0601108	A
C905	0.1 μ	0601108	A
C906	1 μ	0515109	B
C907	1 μ	0535109	B
C908	220 μ F	0514222	3C
C909	0.047 μ F	0657473	3C
TR901	2SC634A (6, 7, 8)	0305891,2,3	B
TR902		0305891,2,3	B
TR903		0305890,1,2	3C
D901	1N34A (K)	0310402	B
D902		0310402	B
D903		0310402	B
D904		0310402	B
D905		0310341	B
D906		0310341	B
RL901	Relay	1150101	A
	Printed Circuit Board F-2041	2591230	
	F-1215	2590230	

TONE CONTROL BLOCK <F-2045>

Stock No. 7560590

W	X	Y	Z
R701	1k Ω	0101102	2A
R702	1k Ω	0101102	1A
R703	470k Ω	0101474	2A
R704	470k Ω	0101474	1A
R705	270k Ω	0101274	2A
R706	270k Ω	0101274	1A
R707	390k Ω	0101394	2A
R708	390k Ω	0101394	1A
R709	18k Ω	0101183	2A, B
R710	18k Ω	0101183	1A, B
R711	1k Ω	0101102	2A
R712	1k Ω	0101102	1A
R713	12k Ω	0101123	2A
R714	12k Ω	0101123	1A
R715	12k Ω	0101123	2A
R716	12k Ω	0101123	1A
R717	820 Ω	0101821	2B
R718	820 Ω	0101821	1B
R719	220 Ω	0101221	2B
R720	220 Ω	0101221	1B
R721	6.8k Ω	0101682	2A
R722	6.8k Ω	0101682	1A
R723	12k Ω	0101123	2A, B
R724	12k Ω	0101123	1A, B
R725	3.3k Ω	0101332	2B
R726	3.3k Ω	0101332	1B
R727	12k Ω	0101123	2B
R728	12k Ω	0101123	1B
R729	12k Ω	0101123	2B
R730	12k Ω	0101123	1B
R731	1k Ω	0101102	2B
R732	1k Ω	0101102	1B
R733	470 Ω	0101471	2B
R734	470 Ω	0101471	1B
R735	470 Ω	0101471	2B
R736	470 Ω	0101471	1B
R737	22 Ω	0101220	2B
R738	22 Ω	0101220	1B
R739	68k Ω	0101683	2B
R740	68k Ω	0101683	1B
R741	390k Ω	0101394	2B
R742	390k Ω	0101394	1B
R743	56k Ω	0101563	2C
R744	56k Ω	0101563	1C
R745	560 Ω	0101561	2B, C
R746	560 Ω	0101561	1B, C
R747	5.6k Ω	0101562	2B
R748	5.6k Ω	0101562	1B
R749	150k Ω	0101154	2C
R750	150k Ω	0101154	1C
R751	6.8k Ω	0101682	2C
R752	6.8k Ω	0101682	1C
R753	820 Ω	0101821	2C
R754	820 Ω	0101821	1C
R755	56k Ω	0101563	2C
R756	56k Ω	0101563	1C

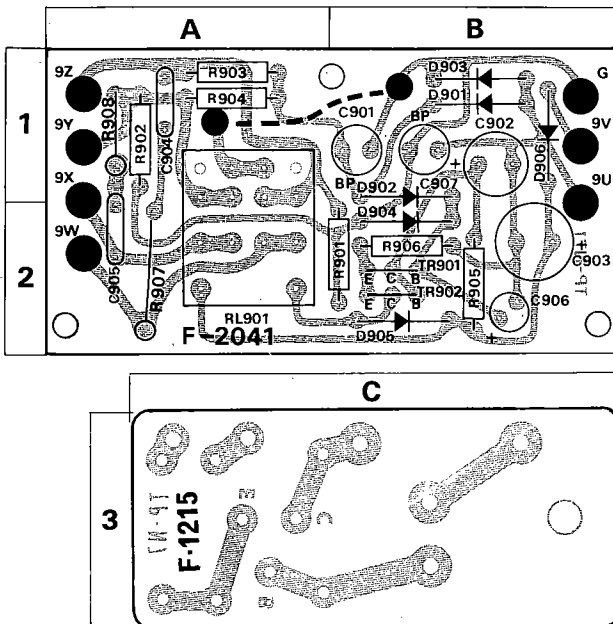

W	X	Y	Z
R757	3.3k Ω } ±10% ¼W CR.	0101332	2C
R758		0101332	1C
R759		0101824	2C
R760		0101824	1C
R761		0101104	2C
R762		0101104	1C
C701	0.22 μ F } ± 5% 50V MC.	0600228	2A
C702		0600228	1A
C703	47 μ F } 16V EC.	0512470	2A
C704		0512470	1A
C705	15pF } ±10% 50V CC.	0660150	2A
C706		0660150	1A
C707	33 μ F } 16V EC.	0512470	2B
C708		0512470	1B
C709	4.7 μ F } 50V EC.	0519106	2A, B
C710		0519106	1A, B
C711	0.01 μ F } ± 5% 50V MC.	0600107	2A, B
C712		0600107	1A, B
C713	0.01 μ F } ± 5% 50V MC.	0600107	2B
C714		0600107	1B
C715	0.0047 μ F } ± 5% 50V MC.	0600476	2B
C716		0600476	1B
C717	1 μ F	0519101	2B

W	X	Y	Z
C718	1 μ F } 50V EC.	0519101	1B
C719		0512100	2C
C720	10 μ F } ±10% 50V CC.	0512100	1C
C721		0660470	2C
C722	47pF } ±10% 50V CC.	0660470	1C
C723		0512100	2C
C724	10 μ F } 16V EC.	0512100	1C
C725		0519101	2C
C726	1 μ F } 50V EC.	0519101	1C
C727		0600207	2C
C728	0.02 μ F } ± 5% 50V MC.	0600207	1C
C729		0600227	2C
C730	0.022 μ F	0600227	1C
TR701	2SA493 (GR)	0300450	2A
TR702		0300450	1A
TR703	2SC1000 (GR)	0305880	2A
TR704		0305880	1A, B
TR705	2SA493 (GR)	0300450	2C
TR706		0300450	1C
TR707	2SA493 (GR)	0300450	2C
TR708		0300450	1C
Printed Circuit Board F-2045		2560550	

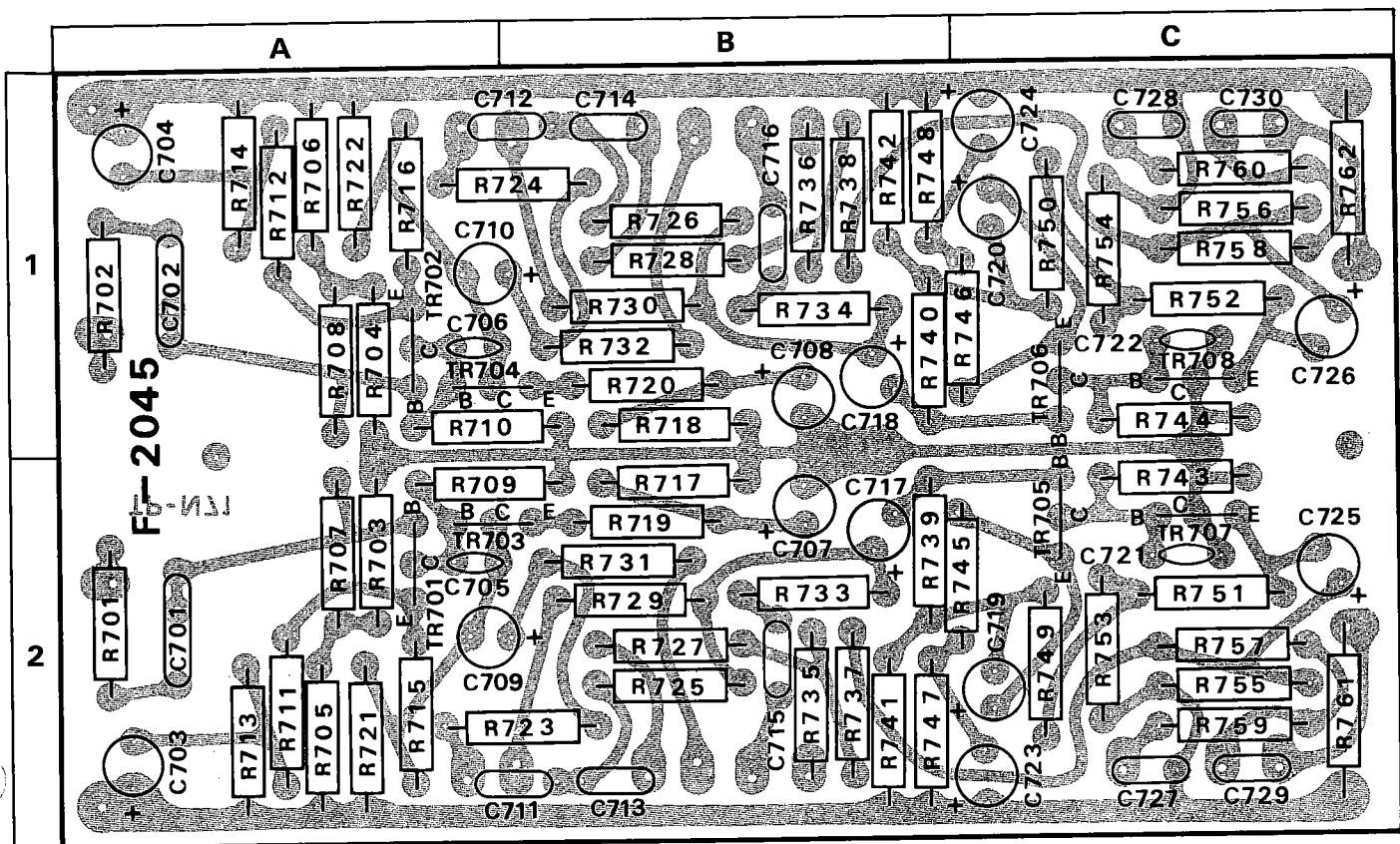

PRINTED CIRCUIT BOARDS AND PARTS LIST

W: Parts No. X: Parts Name Y: Stock No. Z: Position of Parts

EQUALIZER BLOCK <F-2028-A>

Stock No. 7550420

W	X	Y	Z
R601	100kΩ	0101104	2 B
R602	100kΩ	0101104	2 A
R603	47kΩ	0101473	1 B
R604	47kΩ	0101473	1 A
R605	120kΩ	0101124	1 B
R606	120kΩ	0101124	1 A
R607	100kΩ	0101104	1 B
R608	100kΩ	0101104	1 A
R619	100kΩ	0101104	1 B
R610	100kΩ	0101104	1 A
R611	2.2kΩ	0101222	1 B
R612	2.2kΩ	0101222	1 A
R613	220Ω	0101221	1 B
R614	220Ω	0101221	1 A
R615	22kΩ	0101223	1, 2 B
R616	22kΩ	0101223	1 A
R617	100kΩ	0101104	1 B
R618	100kΩ	0101104	1 A
R619	560Ω	0101561	1 B
R620	560Ω	0101561	1 A
R621	560Ω	0101561	1, 2 B
R622	560Ω	0101561	1, 2 A
R623	1.2kΩ	0101122	2 B
R624	1.2kΩ	0101122	2 A
R625	820Ω	0101821	1 B
R626	820Ω	0101821	1 A
R627	68kΩ	0101683	1 B
R628	68kΩ	0101683	1 A
R629	820kΩ	0101824	1, 2 B
R630	820kΩ	0101824	1, 2 A
R631	6.8kΩ	0101682	2 B
R632	6.8kΩ	0101682	2 A
R633	560Ω	0101561	2 B
R634	560Ω	0101561	2 A
R635	27kΩ	0101273	2 B
R636	27kΩ	0101273	2 A
R637	560kΩ	0101564	2 B
R638	560kΩ	0101564	2 A
R641	68kΩ	0101683	2 B
R642	68kΩ	0101683	2 A
R643	1.5kΩ	0101152	2 B
R644	1.5kΩ	0101152	2 A
C601	3.3μF	0573339	1 B
C602	3.3μF	0573339	1 A
C603	10μF	0513100	1 B
C604	10μF	0513100	1 A
C605	33μF	0515330	1 B
C606	33μF	0515330	1 A
C607	150pF	0660151	1 B
C608	150pF	0660151	1 A
C609	47μF	0512470	1 B
C610	47μF	0512470	1 A
C611	33μF	0511330	2 B
C612	33μF	0511330	2 A
C613	12pF	0660120	1 B

±10% 1/4W CR.

W	X	Y	Z
C614	12pF ±10% 50V CC.	0660120	1 A
C615	390pF	0620391	2 B
C616	390pF	0620391	2 A
C617	1500pF	0620152	2 B
C618	1500pF	0620152	2 A
C619	220pF	0620221	2 B
C620	220pF	0620221	2 A
C621	0.008μF	0600806	2 B
C622	0.008μF	0600806	2 A
C623	10μF	0515100	2 B
C624	10μF	0515100	2 A
C625	1μF	0519101	2 B
C626	1μF	0519101	2 A
TR601	2SA726R (F, G)	0300410,1	1 B
TR602		0300410,1	1 A
TR603	2SC1313R (F, G)	0306070,1	1 B
TR604		0306070,1	2 A
TR605	2SA726R (F, G)	0300410,1	2 B
TR606		0300410,1	2 A
	Printed Circuit Board F-2028	2550330	

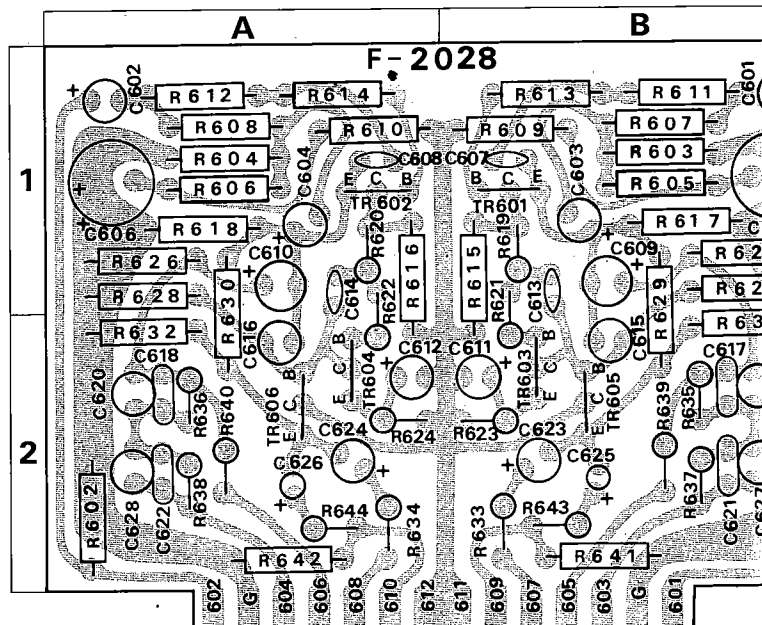

ACCESSORY BLOCK <F-2036>

W	X	Y
R509	10k Ω	0101103
R510	10k Ω	0101103
R511	22k Ω	0101223
R512	22k Ω	0101223
R513	680k Ω	0101684
R514	680k Ω	0101684
C503	390pF	0610391
C504	390pF	0610391
C505	0.02 μ F	0601207
C506	0.02 μ F	0601207
S4	MODE SWITCH	1170170
S5	MUTING SWITCH	1170270
S6	LOUDNESS SWITCH	1170270
	Printed Circuit Board F-2036	2591250

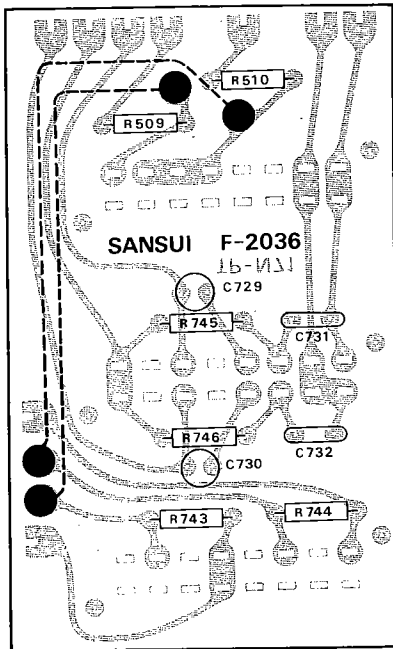

POWER SUPPLY BLOCK <F-2013-1A>

Stock No. 7500690

W	X	Y	Z
R001	2.2k Ω	0101222	A
R002	18k Ω	0101183	A
R003	18k Ω	0101183	B
R004	1k Ω	0101102	A
R005	2.7k Ω	0101272	B
R006	33k Ω	0101333	B
R007	78k Ω	0101683	B
R008	150 Ω	0103151	A
R009	560 Ω	0103561	B
C009	10 μ F	100V EC.	0519404 A
C010	10 μ F	50V EC.	0515100 A
C011	0.047 μ F	+80% -20% 50V CC.	0557473 B
C012	10 μ F	50V EC.	0515100 B
C013	0.01 μ F	+80% -20% 50V CC.	0557103 B
C014	470 μ F	50V EC.	0515471 B
TR001	2SB507 (C, D, E, F)	0303230,1,2,3	A
TR002	2SA678 (6, 7)	0300291,2	B
TR003		0300291,2	B
ZD	ZB-1-14	0315071	B
D002	10D-1	0310340	A
D003		0310340	A
D004		0310340	A
D005		0310340	A
		Printed Circuit Board F-2013-1	2500570

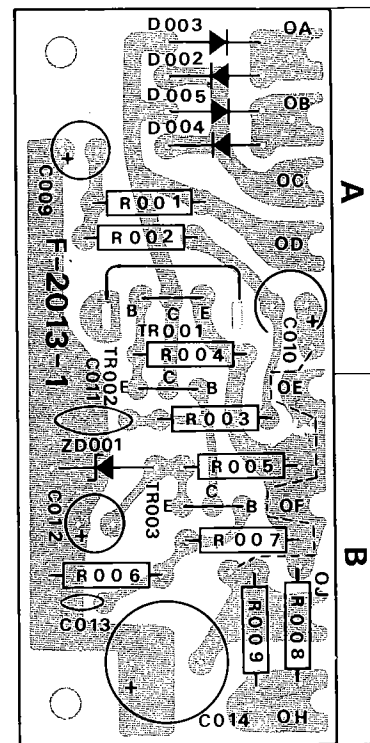

OTHER PARTS AND THEIR POSITION ON CHASSIS

W: Parts No. X: Parts Name Y: Stock No.

OTHER PARTS

W	X	Y
R505	100k Ω	0101104
R506	100k Ω	0101104
R507	180k Ω	0101184
R508	180k Ω	0101184
R511	100k Ω	0101104
R512	100k Ω	0101104
R513	100k Ω	0101104
R514	100k Ω	0101104
R515	100k Ω	0101104
R516	100k Ω	0101104
R517	100k Ω	0101104
R518	100k Ω	0101104
R853	0.47 Ω	0155478
R854	0.47 Ω	0155478
R855	0.47 Ω	0155478
R856	0.47 Ω	0155478
R857	4.7 Ω	0154479
R858	4.7 Ω	0104479
R859	390 Ω	0104391
R860	390 Ω	0104391
R008	4.7k Ω	0104472
R009	4.7k Ω	0104472
VR701	250k Ω (M, N) BALANCE	1010580
VR702		
VR703		
VR704		
VR705	250k Ω (B) \times 2 VOLUME	1010580
VR706		
VR707	100k Ω (W) \times 2 BASS	1010840
VR708		
VR708	100k Ω (Special B) \times 2 TREBLE	1010860
C501	0.047 μ F	0660473
C502	0.047 μ F	0660473
C823	0.1 μ F	0590108
C824	0.1 μ F	0590108
C001	0.022 μ F	0605227
C002	0.0047 μ F	0605476
C004	6800 μ F	0559321
C005	6800 μ F	0559321
C008	2200 μ F	0559820
C014	1000 μ F	0559302
TR813	2SD188 (L, M)	0308301, 2
TR814		0308301, 2
TR815		0300231, 2
TR816		0300231, 2
	Power Transistor Socket	2030020
D001	5B2	0310660
L801	Stabilized Coil for High Frequency Range	4290221
L802		4390221
S1	SELECTOR	1103490
S2	TAPE MONITOR	1170300
S3	4-CH ADAPTOR	1170300
S7	HIGH FILTER	1170270

W	X	Y
S8	LOW FILTER	1170270
S9	POWER/SPEAKERS	1101420
J801	Headphone Jack	2430220
J601	DIN Socket	2430040
T001	Power Transformer	4001171
CO001	AC Outlet (UNSWITCHED)	2450040
CO002	AC Outlet (SWITCHED)	2450040
CO003		2450040
F001	Power Fuse (3A)	0431262
	Power Fuse Holder	2300060
F002	+ Power Supply, Left Ch.	Quick Acting Fuse (3A)
F003	+ Power Supply, Left Ch.	
F004	- Power Supply, Right Ch.	
F005	- Power Supply, Right Ch.	
F01	1A	Wired-in Fuse
F02	1A	
F03	3A	
	Printed Circuit Board For Wired-in Fuse (F-1456)	2598120
PL001	Power Indicator (6.3V 250mA)	0400090
	Power Indicator Socket	2320080
PU001	Voltage Selector Plug	2410090
	Socket	2410080

* Design and specifications subject to change without notice for improvements.

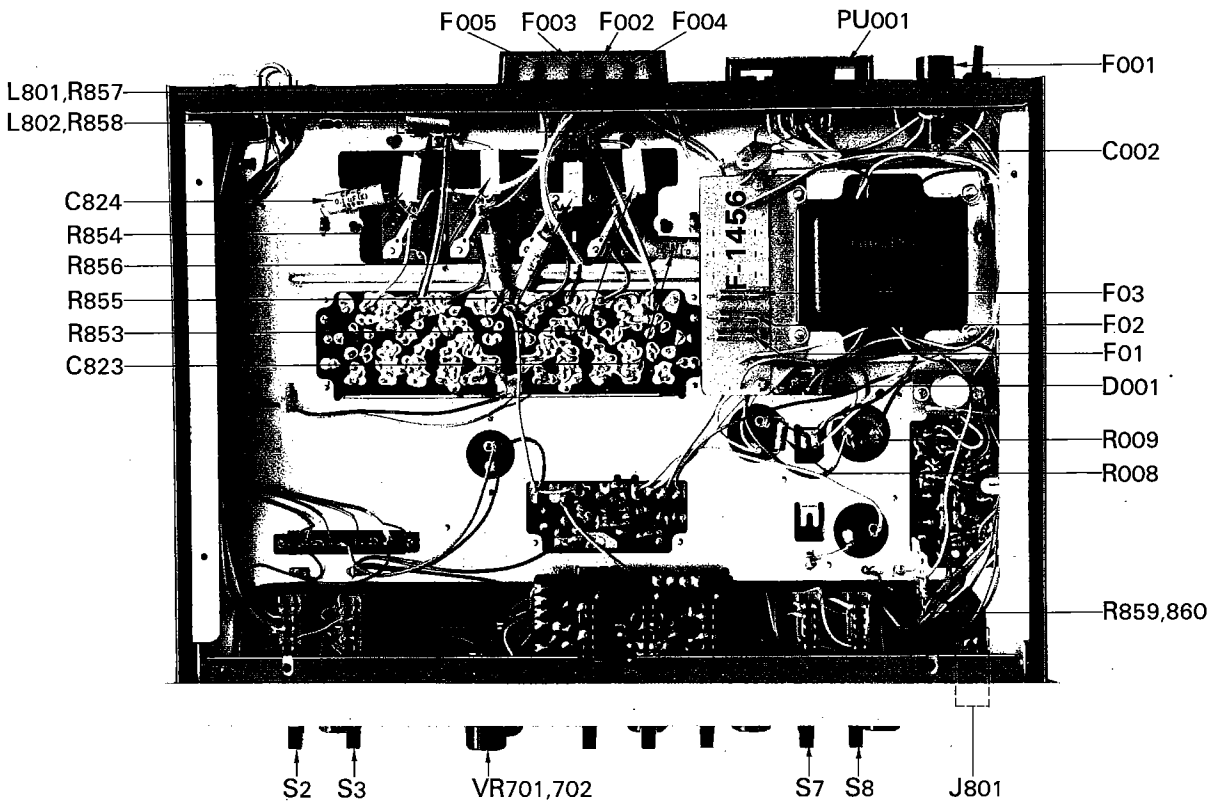
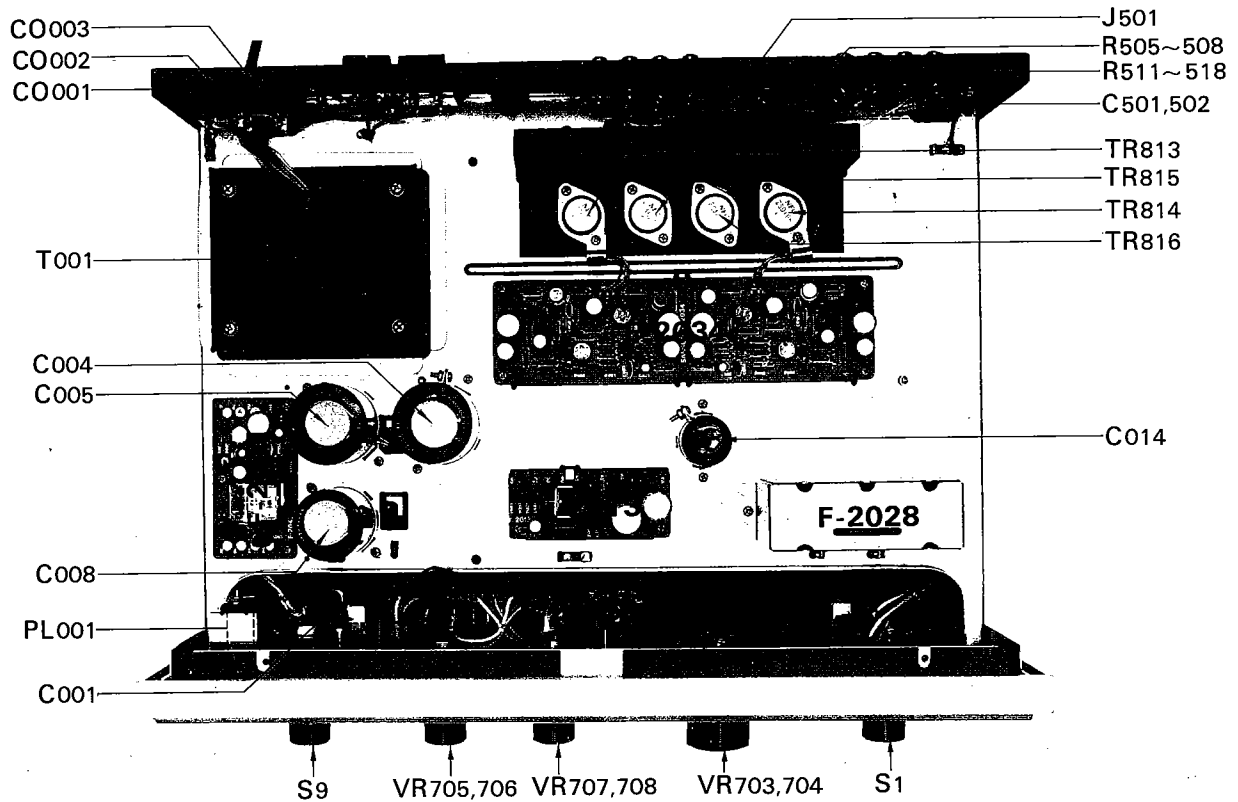



SANSUI ELECTRIC CO., LTD.

14-1, 2-chome, Izumi, Suginami-ku, Tokyo 168, Japan.
TELEPHONE: (03) 323-1111 / TELEX: 232-2076

Stock No. 9206980

Printed in Japan (43100M3)



Sansui[®]



SANSUI ELECTRIC COMPANY LIMITED



Head Office: 14-1, 2-chome, Izumi, Suginami-ku, Tokyo, Japan. TEL. 328-0111

Printed in Japan (O7600M11)

REMOVALS DISASSEMBLE DIAL CORD STATIONS

DISASSEMBLE REMOVALS

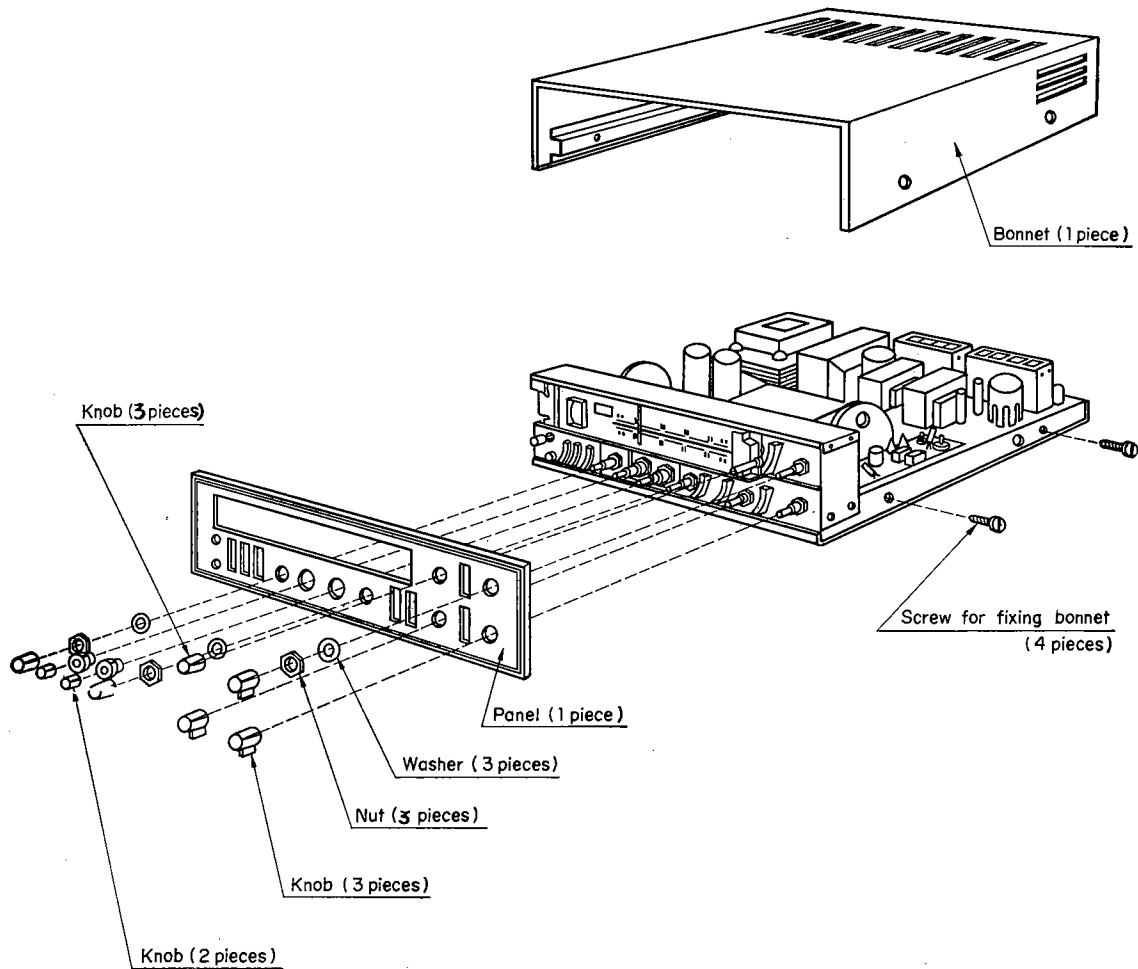

DIAL CORD STRINGS

